

SCHRAUBEN

Visserie / Viteria

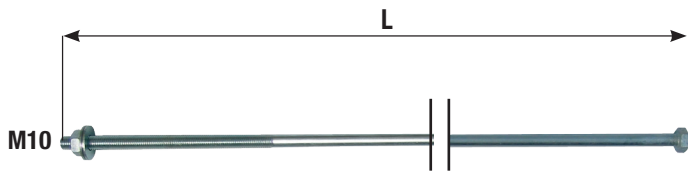

Treppenschrauben mit Unterlagscheibe und Mutter

Boulons d'escaliers avec rondelles et écrous

Bullone per scala con rondelle e dado

1970..

No. Art.		Ø D	L	
1970 0700 03	ZINK	10	700	1
1970 0800 03	ZINK	10	800	1
1970 0900 03	ZINK	10	900	1
1970 1000 03	ZINK	10	1000	1
1970 1100 03	ZINK	10	1100	1
1970 1200 03	ZINK	10	1200	1
1970 1300 03	ZINK	10	1300	1

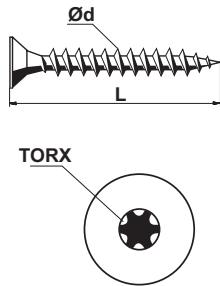

Spanplattenschrauben, Senkkopf mit Torx Flach

Vis pour panneau agglo., tête conique plate Torx.

Vite legno, testa svasata Torx

1980..

No. Art.		L	Ø d	
1980 3525 05	ZINK	25	3,5	100
1980 4025 05	ZINK	25	4,0	100
1980 4525 05	ZINK	25	4,5	100
1980 5025 05	ZINK	25	5,0	100
1980 4530 05	ZINK	30	4,5	100
1980 5030 05	ZINK	30	5,0	100
1980 4535 05	ZINK	35	4,5	100
1980 4040 05	ZINK	40	4,0	100
1980 4540 05	ZINK	40	4,5	100
1980 3525 03	ZINK	25	3,5	100
1980 4525 03	ZINK	25	4,5	100
1980 5025 03	ZINK	25	5,0	100
1980 4530 03	ZINK	30	4,5	100
1980 4535 03	ZINK	35	4,5	100
1980 4040 03	ZINK	40	4,0	100
1980 4540 03	ZINK	40	4,5	100
1980 5030 03	ZINK	30	5,0	100

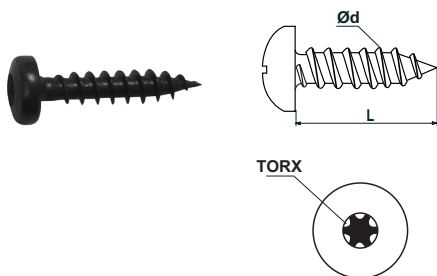

Spanplattenschrauben, Pan-head mit Torx

Vis pour panneau agglo., Pan-head Torx

Vite legno, Pan-Head Torx

1981..

No. Art.		Ø d	L	
1981 5020 05	ZINK	5	20	100
1981 5025 05	ZINK	5	25	100
1981 5030 05	ZINK	5	30	100
1981 6030 05	ZINK	6	30	100
1981 5020 03	ZINK	5	20	100
1981 5025 03	ZINK	5	25	100
1981 5030 03	ZINK	5	30	100
1981 6030 03	ZINK	6	30	100



Flachrundschraben mit 4kt-Ansatz und 6kt-Mutter

Boulon tête bombée, collaré carré, écrou 6 pans

Bullone testa tonda, sottotesta quadro dado esagonale

1982 M6..

No. Art.		Ø d	L	
1982 M630 05	ZINK	M6	30	100
1982 M635 05	ZINK	M6	35	100
1982 M640 05	ZINK	M6	40	100
1982 M645 05	ZINK	M6	45	100
1982 M650 05	ZINK	M6	50	100
1982 M655 05	ZINK	M6	55	100
1982 M660 05	ZINK	M6	60	100
1982 M665 05	ZINK	M6	65	100
1982 M630 03	ZINK	M6	30	200
1982 M635 03	ZINK	M6	35	200
1982 M640 03	ZINK	M6	40	200
1982 M645 03	ZINK	M6	45	200
1982 M650 03	ZINK	M6	50	200
1982 M655 03	ZINK	M6	55	200
1982 M660 03	ZINK	M6	60	200
1982 M665 03	ZINK	M6	65	200

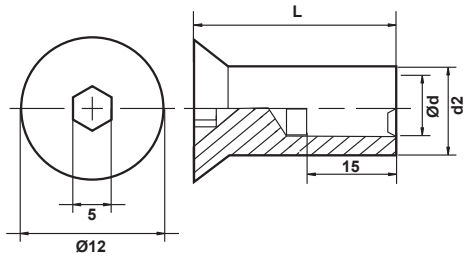

Hülsmutter, Senkkopf, Inbus

Ecrou à douille, tête fraisée, inbus
Dado a boccola, testa svasata

1983 M6..

No. Art.		Ø d	d2	L	
1983 M620 05	ZINK	M 6	7,5	20	100
1983 M620 03	ZINK	M 6	7,5	20	100

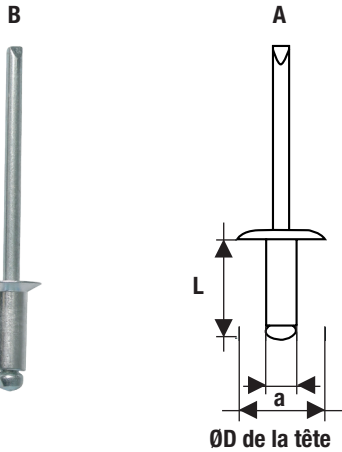

Blindniete Flachkopf

Rivet aveugle, tête plate
Rivetto cieco, testa piatta

1984..

No. Art.		Ø D	L	A/B	
1984 3018 00	ALU/STAHL	3	18	A	1000
1984 4010 00	ALU/STAHL	4	10	A	1000
1984 4012 00	ALU/STAHL	4	12	A	1000
1984 5010 00	ALU/STAHL	5	10	A	500
1984 5012 00	ALU/STAHL	5	12	A	500
1984 4010 11	ALU/INOX	4	10	A	1000
1984 4012 11	ALU/INOX	4	12	A	1000
1984 5010 11	ALU/INOX	5	10	A	500
1984 5012 11	ALU/INOX	5	12	A	500
1984 4010 11	ALU/INOX	4	10	B	1000

INOX A2
Stainless steel

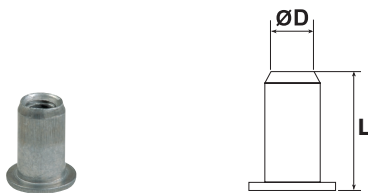

Einnietmutter Aluminium

Ecrou à sertir aluminium
Boccola filettata alluminio

1939 M..

No. Art.		L	Ø D	
1939 M516 00	ALU	16	M 5	100
1939 M616 00	ALU	16	M 6	100

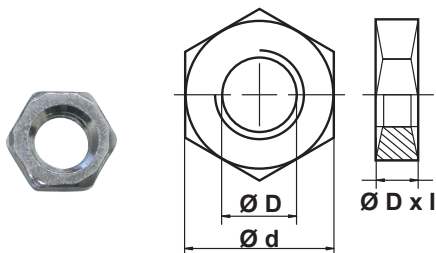

Sechskant Mutter

Ecrou six pans
Dado esagonale

199M..

No. Art.		Ø D	l	Ø d	
199M 6008 03	ZINK	M 6	0,8	10	100
199M 1005 03	ZINK	M 10	0,5	16	100
199M 1008 03	ZINK	M 10	0,8	16	100
199M 1005 07	ZINK	M 10	0,5	16	100
199M 1008 07	ZINK	M 10	0,8	16	100
199M 6008 05	SCHW	M 6	0,8	10	100
199M 1005 05	SCHW	M 10	0,5	16	100
199M 1008 05	SCHW	M 10	0,8	16	100
199M 5008 11	INOX	M 5	0,8	8	100
199M 6008 11	INOX	M 6	0,8	10	100

INOX A2
Stainless steel

**Kunststoffdübel***Tampon plastique**Tassello nylon***1992 1..**

No. Art.		Ø D	L	
1992 1090 98	ORA	10	90	100
1992 1490 82	GRAU	14	90	100
1992 1412 82	GRAU	14	120	100

Kunststoffdübel mit Rand Grau*Tampon nylon avec collerette couleur gris**Tassello nylon con collare colore grigio***1993 14..**

No. Art.		Ø D	L	
1993 1490 82	GRAU	Ø 14	90	50

**Unterlagscheiben 1/2 stark***Rondelle 1/2 forte**Rondella 1/2 forte***3330..**

No. Art.		Ø d	Ø D	Ep.	
3330 0313 03	ZINK	3,2	13	0,5	100
3330 0414 03	ZINK	4,3	14	0,8	100
3330 0510 03	ZINK	5,3	10	0,8	100
3330 0515 03	ZINK	5,3	15	0,8	100
3330 0612 03	ZINK	6,4	12,5	0,8	100
3330 0616 03	ZINK	6,4	16	0,8	100
3330 0714 03	ZINK	7,4	14	0,8	100
3330 0717 03	ZINK	7,4	17	0,8	100
3330 0817 03	ZINK	8,4	17	0,8	100
3330 0820 03	ZINK	8,4	20	1,2	100
3330 1021 03	ZINK	10,5	21	1,2	100
3330 1025 03	ZINK	10,5	25	1,2	100
3330 1324 03	ZINK	13,0	24	1,2	100
3330 1330 03	ZINK	13,0	30	1,6	100
3330 1535 03	ZINK	15,0	35	1,6	100
3330 1740 03	ZINK	17,0	40	1,6	100
3330 2155 03	ZINK	21,0	55	2,0	100
3330 2560 03	ZINK	25,0	60	3,0	100
3330 3160 03	ZINK	31,0	60	3,0	100
3330 3670 03	ZINK	36,0	70	3,0	100
3330 0616 05	SCHW	6,4	16	0,8	100

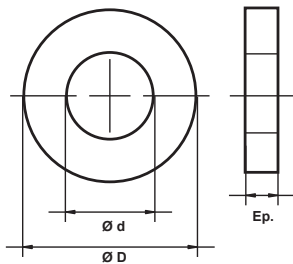
**Unterlagscheiben stark***Rondelle forte**Rondella forte***3340..**

No. Art.		Ø d	Ø D	Ep.	
3340 0515 03	ZINK	5,3	15	1,6	100
3340 0616 03	ZINK	6,4	16	1,6	100
3340 0717 03	ZINK	7,4	17	1,6	100
3340 0820 03	ZINK	8,4	20	2,0	100
3340 1025 03	ZINK	10,5	25	2,0	100
3340 1330 03	ZINK	13	30	3,0	100
3340 1535 03	ZINK	15	35	3,0	100
3340 1740 03	ZINK	17	40	3,0	100
3340 1950 03	ZINK	19	50	4,0	100
3340 2155 03	ZINK	21	55	4,0	100
3340 2560 03	ZINK	25	60	4,0	100
3340 3160 03	ZINK	31	60	4,0	100
3340 3670 03	ZINK	36	70	4,0	100

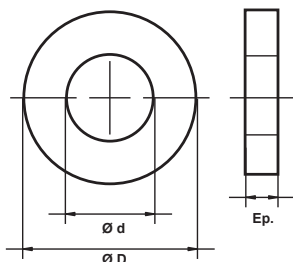

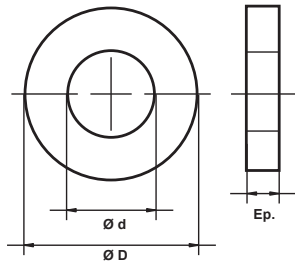

Unterlagscheiben Carrosserie

3350..

Rondelle de carrosserie

Rondella da carrozzeria

No. Art.		Ø d	Ø D	Ep.	
3350 0520 03	ZINK	5,3	20	1,5	100
3350 0620 03	ZINK	6,4	20	1,5	100
3350 0625 03	ZINK	6,4	25	1,8	100
3350 0720 03	ZINK	7,4	20	1,5	100
3350 0725 03	ZINK	7,4	25	1,8	100
3350 0735 03	ZINK	7,4	35	2,5	100
3350 0825 03	ZINK	8,4	25	1,8	100
3350 0830 03	ZINK	8,4	30	2	100
3350 0835 03	ZINK	8,4	35	2,5	100
3350 0930 03	ZINK	9,4	30	2	100
3350 0935 03	ZINK	9,4	35	2,5	100
3350 0940 03	ZINK	9,4	40	2,5	100
3350 1030 03	ZINK	10,5	30	2	100
3350 1035 03	ZINK	10,5	35	2,5	100
3350 1040 03	ZINK	10,5	40	2,5	100
3350 1245 03	ZINK	12,5	45	2,5	100

Fischbandringe

3460..

Rondelle pour fiche

Rondella Grower

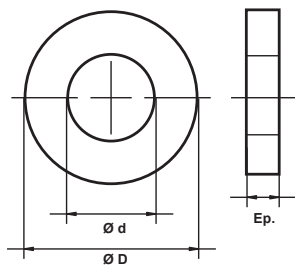

No. Art.		Ø d	Ø D	Ep.	
3460 0711 03	ZINK	7	11	2	100
3460 0812 03	ZINK	8	12	2	100
3460 0913 03	ZINK	9	13	2	100
3460 1014 03	ZINK	10	14	2	100
3460 1115 03	ZINK	11	15	2	100
3460 1216 03	ZINK	12	16	2	100
3460 1317 03	ZINK	13	17	2	100
3460 1418 03	ZINK	14	18	2	100
3460 1520 03	ZINK	15	20	2	100
3460 1622 03	ZINK	16	22	2	100
3460 1824 03	ZINK	18	24	2	100

Federring Din 127 B

3380..

Rondelle à ressort Din 127 B

Rondella per molla Din 127 B

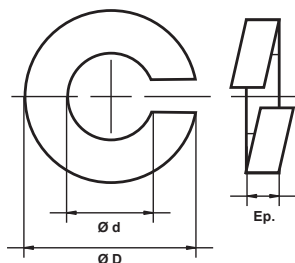

No. Art.		Ø d	Ø D	
* 3380 0204 03	ZINK	M2	4,4	100
* 3380 0306 03	ZINK	M3	6,2	100
* 3380 0407 03	ZINK	M4	7,6	100
* 3380 0409 03	ZINK	M5	9,2	100
* 3380 0611 03	ZINK	M6	11,8	100
* 3380 0712 03	ZINK	M7	12,8	100
* 3380 0814 03	ZINK	M8	14,8	100
* 3380 1018 03	ZINK	M10	18,1	100
* 3380 1221 03	ZINK	M12	21,1	100

Unterlagscheiben VSM 13904

Rondelles VSM 13904

Rondella VSM 13904

3300..

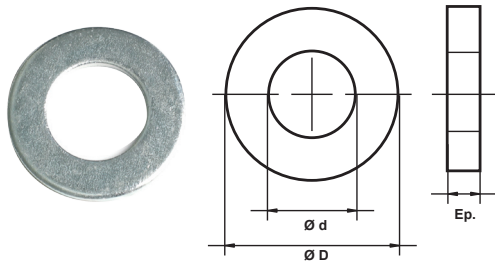

No. Art.		Ø d	Ø D	Ep.	
3300 0307 03	ZINK	3,2	7	0,5	100
3300 0308 03	ZINK	3,7	8	0,5	100
3300 0409 03	ZINK	4,3	9	0,8	100
3300 0510 03	ZINK	5,3	10	1,0	100
3300 0612 03	ZINK	6,4	12,5	1,6	100
3300 0714 03	ZINK	7,4	14	1,6	100
3300 0817 03	ZINK	8,4	17	1,6	100
3300 1324 03	ZINK	13	24	2,5	100
3300 1328 03	ZINK	13	28	4,0	100
3300 1528 03	ZINK	15	28	2,5	100
3300 1530 03	ZINK	15	30	4,0	100
3300 1730 03	ZINK	17	30	3,0	100
3300 1734 03	ZINK	17	34	4,0	100
3300 1934 03	ZINK	19	34	3,0	100
3300 1937 03	ZINK	19	37	4,0	100
3300 2137 03	ZINK	21	37	3,0	100
3300 2139 03	ZINK	21	39	4,0	100
3300 2339 03	ZINK	23	39	3,0	100
3300 2344 03	ZINK	23	44	4,0	100
3300 2544 03	ZINK	25	44	4,0	100
3300 2850 03	ZINK	28	50	4,0	100
3300 3156 03	ZINK	31	56	4,0	100

Unterlagscheiben VSM 13908

Rondelles VSM 13908

Rondella VSM 13908

3320..

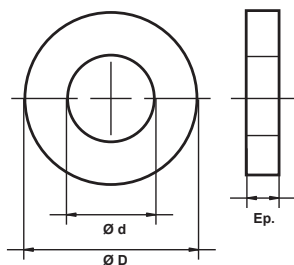

No. Art.		Ø d	Ø D	Ep.	
3320 0306 03	ZINK	3,2	6	0,5	100
3320 0307 03	ZINK	3,7	7	0,5	100
3320 0408 03	ZINK	4,3	8	0,8	100
3320 0509 03	ZINK	5,3	9,5	1,0	100
3320 0611 03	ZINK	6,4	11	1,6	100
3320 0814 03	ZINK	8,4	14	1,6	100
3320 1018 03	ZINK	10,5	18	2,0	100
3320 1320 03	ZINK	13	20	2,5	100
3320 1524 03	ZINK	15	24	2,5	100
3320 1727 03	ZINK	17	27	3,0	100
3320 1930 03	ZINK	19	30	3,0	100
3320 2133 03	ZINK	21	33	3,0	100

Unterlagscheiben Messing

Rondelle laiton

Rondella ottone

3440..

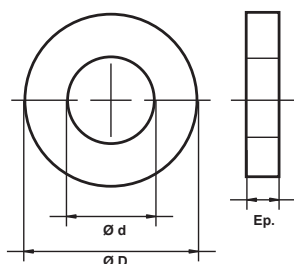

No. Art.		Ø d	Ø D	Ep.	
3440 0307 60	MESSING	3,2	7	0,5	100
3440 0409 60	MESSING	4,3	9	0,8	100
3440 0414 60	MESSING	4,3	14	0,8	100
3440 0510 60	MESSING	5,3	10	1,0	100
3440 0515 60	MESSING	5,3	15	1,0	100
3440 0817 60	MESSING	8,4	17	1,5	100
3440 1021 60	MESSING	10,5	21	1,2	100
3440 1324 60	MESSING	13	24	2,5	100

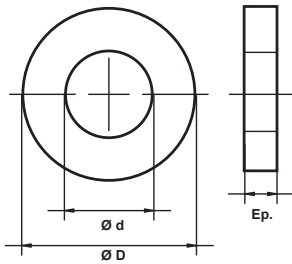

Unterlagscheiben Aluminium

Rondelle aluminium

Rondella alluminio

3441..

No. Art.		Ø d	Ø D	Ep.	
3441 0412 00	ALU	4,3	12	0,5	100
3441 0414 00	ALU	4,3	14	0,5	100
3441 0515 00	ALU	5,3	15	0,8	100
3441 0818 00	ALU	8,4	18	1,0	100
3441 0920 00	ALU	9,4	20	1,6	100
3441 1022 00	ALU	10,5	22	1,6	100

Scheiben ohne Loch

Rondelle sans trou

Rondella senza foro

3360..

No. Art.		Ø D	Ep.	
3360 2002 00	ROH	20	2	100
3360 2003 00	ROH	20	3	100
3360 2502 00	ROH	25	2	100
3360 2503 00	ROH	25	3	100
3360 3003 00	ROH	30	3	100
3360 4003 00	ROH	40	3	100
3360 4503 00	ROH	45	3	100
3360 5003 00	ROH	50	3	100
3360 6003 00	ROH	60	3	100
3360 7003 00	ROH	70	3	100
3360 8003 00	ROH	80	3	100

